

Marchio / Brand ZUCCHETTI

Classe / Class INOX

HELM

ZHL738.X

Batteria incasso doccia. / Built-in shower mixer.



Batteria incasso doccia in acciaio inox AISI 316L, rubinetti Hot and Cold















Built-in shower mixer in AISI 316L stainless steel, taps Hot and Cold.

R99503



Parte incasso. / Built-in part.

Finiture / Finishes

 X Acciaio inox spazzolato / Brushed stainless steel	 XG2 Acciaio inox spazz.-godr. verticale / Br. stainless steel - Vertical knurling	 XG3 Acciaio inox spazz.-godronatura diagonale / Br. stainless steel-diagonal knurling	 XP31 Brushed PVD British gold / -	 XP31G2 Br. PVD British gold-godr. verticale / Br. PVD British gold-vertical knurling	 XP31G3 Br. PVD British gold-godr. diagonale / Br. PVD British gold-diagonal knurling	 XP41 Brushed PVD gold / Brushed PVD gold	 XP41G2 Br. PVD gold-godronatura verticale / Brushed PVD gold-vertical knurling
 XP41G3 Br. PVD gold-godr. diagonale / Br. PVD gold-diagonal knurling	 XP81 PVD Brushed Total Black / PVD Brushed Total Black	 XP81G2 Br. PVD Total Black-godr. verticale / Br. PVD Total Black-vertical knurling	 XP81G3 Br. PVD Total Black-godr. diagonale / Br. PVD Total Black-diagonal knurling	 XP91 Brushed PVD copper / Brushed PVD copper	 XP91G2 Br. PVD copper-godr. verticale / Br. PVD copper-vertical knurling	 XP91G3 Br. PVD copper-godr. diagonale / Br. PVD copper-diagonal knurling	

HELM

ZHL738.X

Disegno Complessivo / Overall Drawing

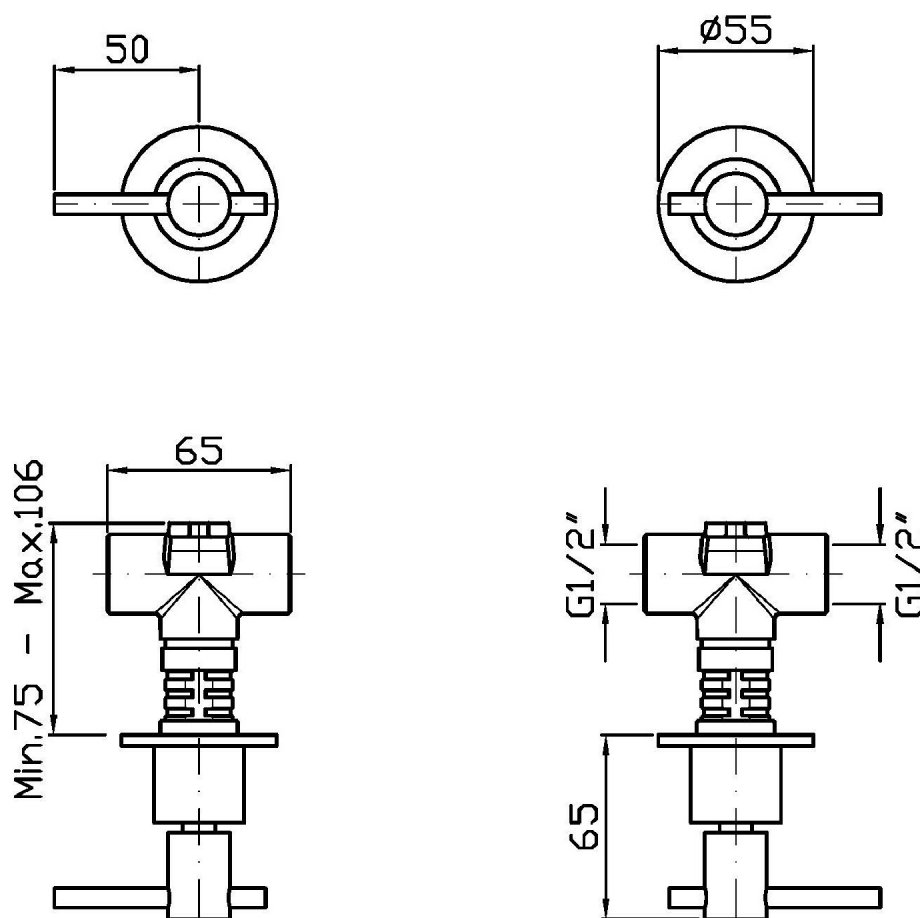

HELM

ZHL738.X Portate / Flowrates (lt/min)

PRESSIONE PRESSURE	1 BAR	2 BAR	3 BAR	4 BAR	5 BAR
1 RUBINETTO APERTO <i>P1</i>	15,3	21,7	26,6	30,6	34,5
2 RUBINETTO APERTI 2 TAPS OPENED <i>P2</i>	30,6	43,4	53,2	61,2	69
<i>P3</i>					
<i>P4</i>					
<i>P5</i>					

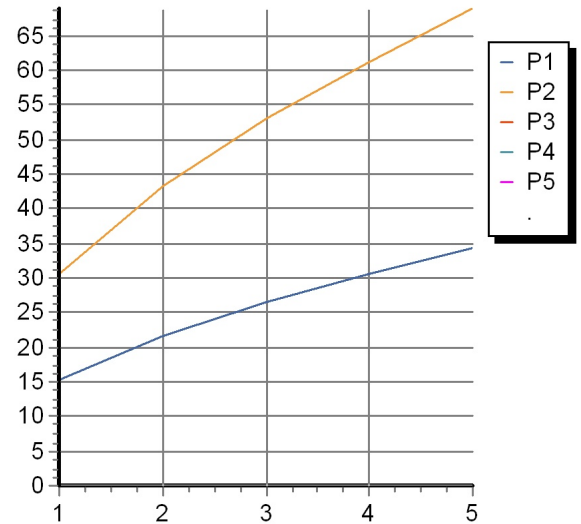

HELM

ZHL738.X Pesì e Misure / Weights and Sizes

Peso (Kg) Weight (lb)	1,00 (Kg)	2,20 (lb)
Volume test (dc3) - (in3)	7,50 (dc3)	457,68 (in3)
h (mm) - (in)	90,00 (mm)	3,54 (in)
L1 (mm) - (in)	250,00 (mm)	9,84 (in)
L2 (mm) - (in)	333,00 (mm)	13,11 (in)

