

## HELM

ZHL662.X

Termostatico incasso doccia con 4 rubinetti d'arresto. / Built-in thermostatic shower mixer with 4 stop valves.



Termostatico incasso doccia da 1/2", in acciaio inox AISI 316L, con 4 rubinetti d'arresto.



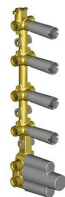

1/2" built-in thermostatic shower mixer in AISI 316L stainless steel, with 4 stop valves.

R97823

Parte incasso. / Built-in part.

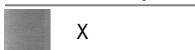
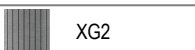
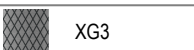
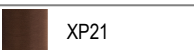
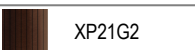
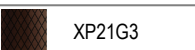
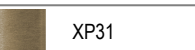
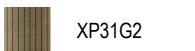
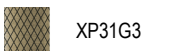

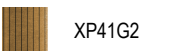
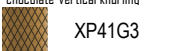
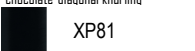
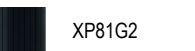
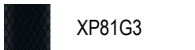
## Finiture / Finishes

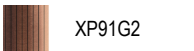
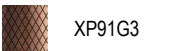
 X Acciaio inox spazzolato / Brushed stainless steel	 XG2 Acciaio inox spazz.-godr. verticale / Br. stainless steel-Vertical knurling	 XG3 Acciaio inox spazz.-godronatura diagonale / Br. stainless steel-diagonal knurling	 XP21 Brushed PVD chocolate / Brushed PVD chocolate	 XP21G2 Brushed PVD chocolate godronatura verticale / Brush. PVD chocolate-vertical knurling	 XP21G3 Brushed PVD chocolate-godronatura diagonale / Brush. PVD chocolate-diagonal knurling	 XP31 Brushed PVD British gold / Brushed PVD British gold
 XP31G2 Br. PVD British gold-godr. verticale / Br. PVD British gold-vertical knurling	 XP31G3 Br. PVD British gold-godr. diagonale / Br. PVD British gold-diagonal knurling	 XP41 Brushed PVD gold / Brushed PVD gold	 XP41G2 Br. PVD gold-godronatura verticale / Brushed PVD gold-vertical knurling	 XP41G3 Br. PVD gold-godr. diagonale / Br. PVD gold-diagonal knurling	 XP81 PVD Brushed Total Black / PVD Brushed Total Black	 XP81G2 Br. PVD Total Black-godr. verticale / Br. PVD Total Black-vertical knurling
 XP81G3 Br. PVD Total Black-godr. diagonale / Br. PVD Total Black-diagonal knurling	 XP91 Brushed PVD copper / Brushed PVD copper	 XP91G2 Br. PVD copper-godr. verticale / Br. PVD copper-vertical knurling	 XP91G3 Br. PVD copper-godr. diagonale / Br. PVD copper-diagonal knurling			

## HELM

ZHL662.X

Disegno Complessivo / Overall Drawing

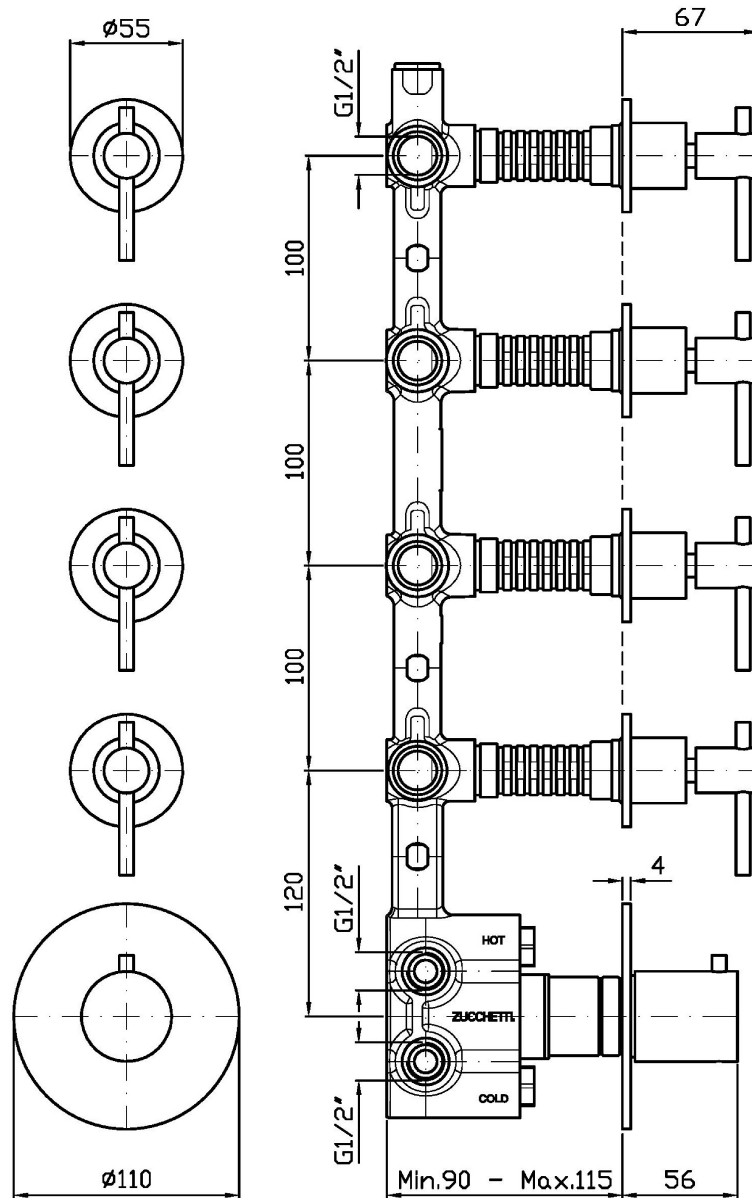

Note / Notes

## HELM

ZHL662.X

Esplosi / Exploded

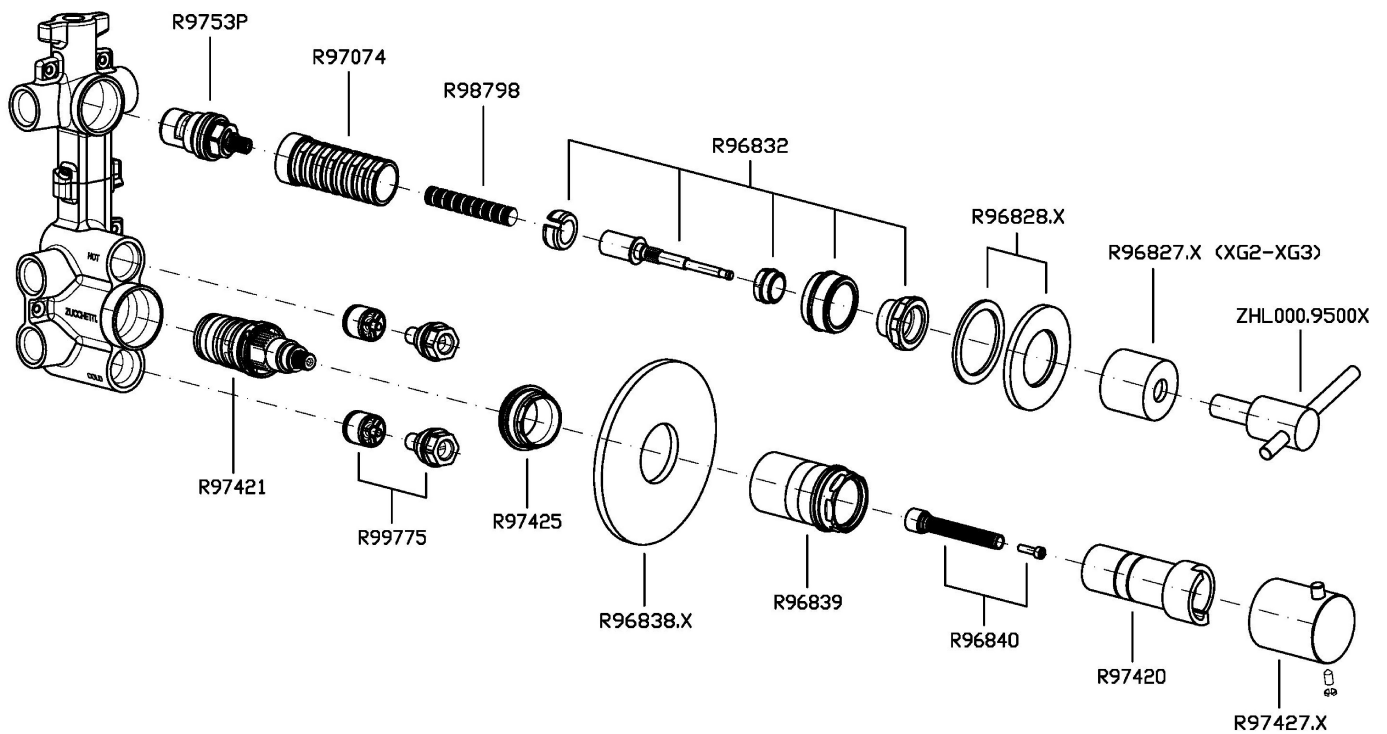

## HELM

ZHL662.X

Portate / Flowrates (lt/min)

PRESSIONE PRESSURE	1 BAR	2 BAR	3 BAR	4 BAR	5 BAR
1 RUBINETTO APERTO <i>P1</i>	13,2	18,4	22,7	26,2	29,2
2 RUBINETTO APERTI 2 TAPS OPENED <i>P2</i>	16,5	23,6	29	33,3	37,6
3 RUBINETTO APERTI 3 TAPS OPENED <i>P3</i>	17,7	25,3	31,3	36,2	40,4
4 RUBINETTO APERTI 4 TAPS OPENED <i>P4</i>	18,5	26	31,9	36,9	41,3
<i>P5</i>					

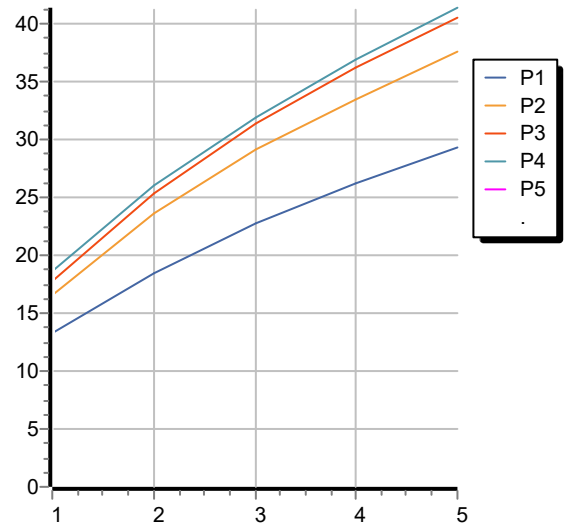

## HELM

ZHL662.X

Pesi e Misure / Weights and Sizes

Peso ( Kg ) Weight ( lb )	2,90 ( Kg )	6,39 ( lb )
Volume test ( dc3 ) - ( in3 )	15,98 ( dc3 )	975,16 ( in3 )
h ( mm ) - ( in )	90,00 ( mm )	3,54 ( in )
L1 ( mm ) - ( in )	335,00 ( mm )	13,19 ( in )
L2 ( mm ) - ( in )	530,00 ( mm )	20,87 ( in )

