

MEDAMEDA

ZMM5766

Batteria lavabo incasso a 3 fori. / 3 hole built-in basin mixer.



Batteria lavabo incasso a 3 fori con aeratore. Lunghezza bocca 215 mm.
Water Saving - portata d'acqua uguale o inferiore a 6 l/min.

3 hole built-in basin mixer, with aerator. Spout projecton L 215 mm.
Water Saving - water flow rate of 6 l/min or less.

R99500

Parte incasso corpo unico, interasse 200 mm /
Assembled built-in part, interaxe 200 mm.













R99504

Parte incasso con elementi liberi, distanza
variabile / Built-in part, not assembled, variable
distance.



Finiture / Finishes

						
Cromo / Chrome	Nickel Spazzolato / Brushed Nickel	Nickel Lucido / Polished Nickel	Oro / Gold	Oro spazzolato / Brushed Gold	Metal Black / Metal Black	Metal Black spazzolato / Brushed Metal Black
						
Nero Opaco Goffrato / Embossed Matt Black	Brushed PVD British gold / Brushed PVD British gold	Brushed total black PVD / Brushed total black PVD				

MEDAMEDA

ZMM5766

Disegno Complessivo / Overall Drawing

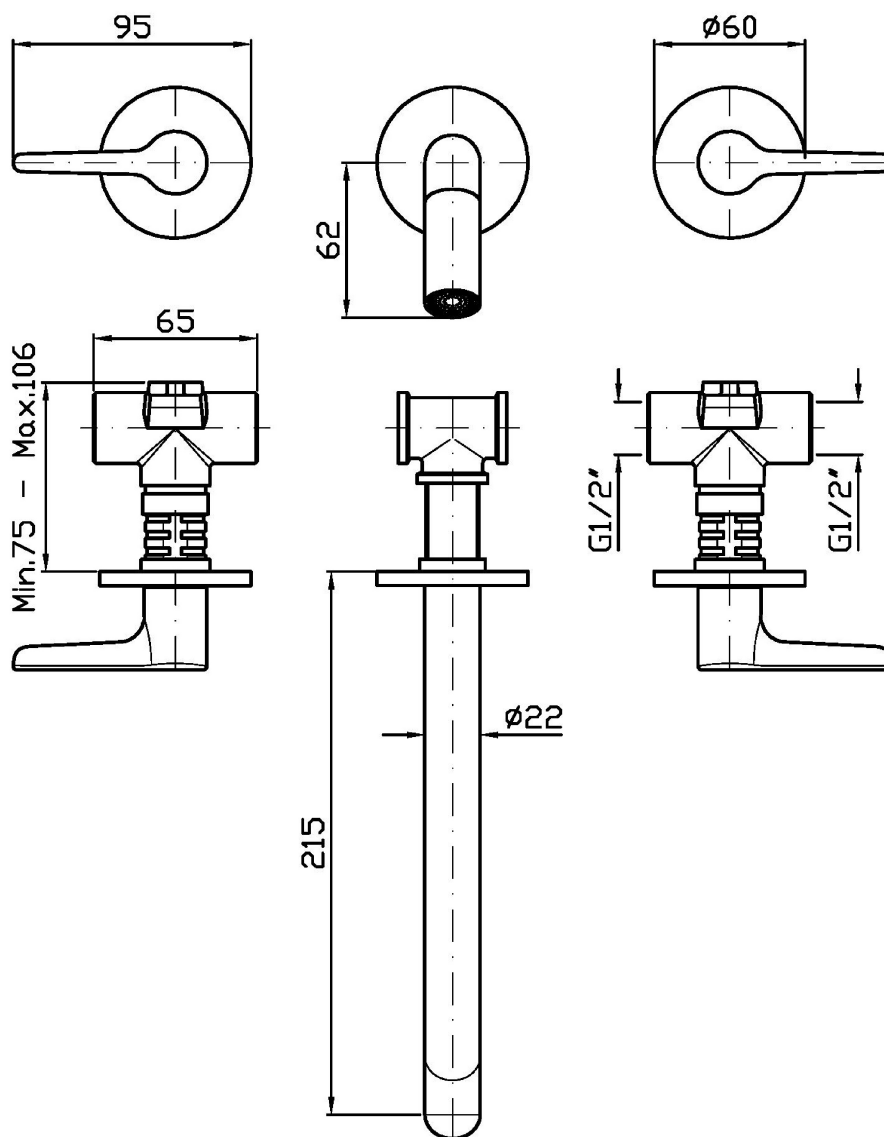

Note / Notes

MEDAMEDA

ZMM5766

Esplosi / Exploded

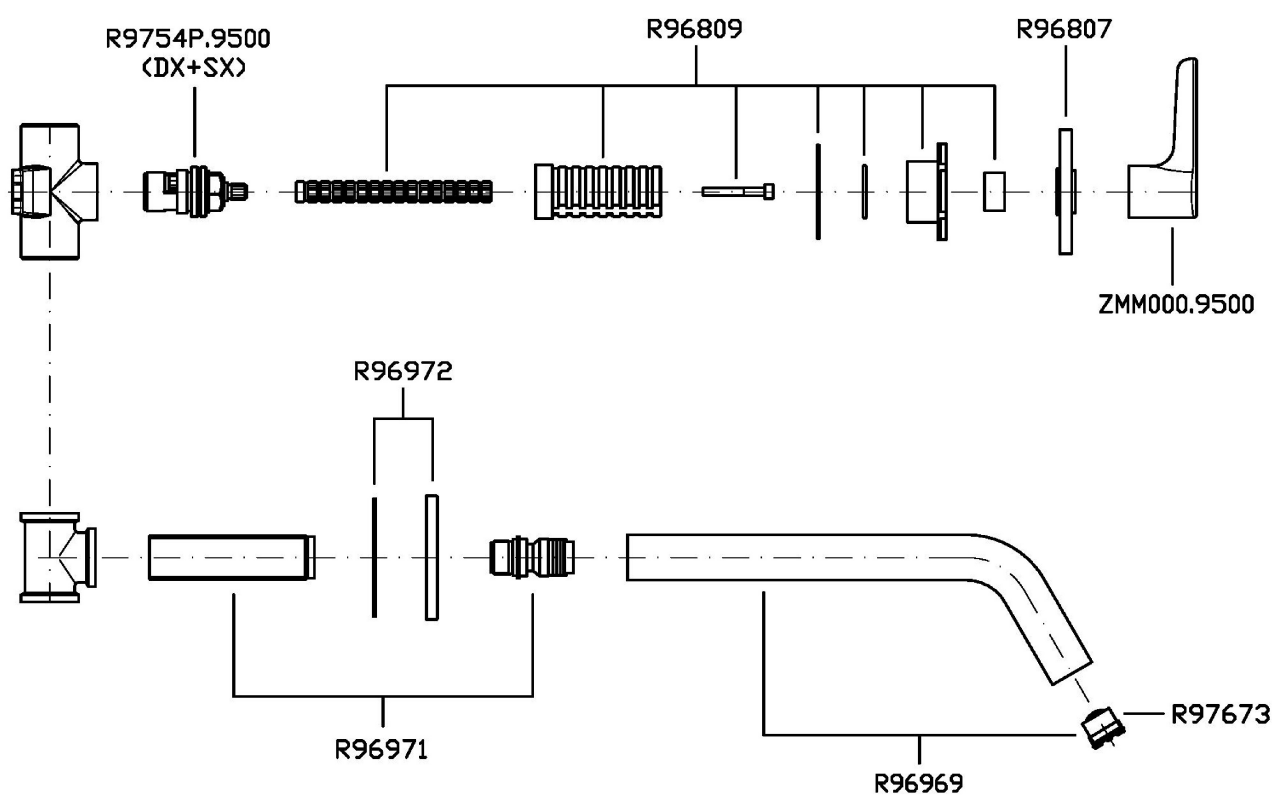

MEDAMEDA

ZMM5766 Portate / Flowrates (lt/min)

PRESSIONE PRESSURE	1 BAR	2 BAR	3 BAR	4 BAR	5 BAR
P1 LAVABO BASIN	2,9	3,8	4,2	4,3	4,5
P2					
P3					
P4					
P5					

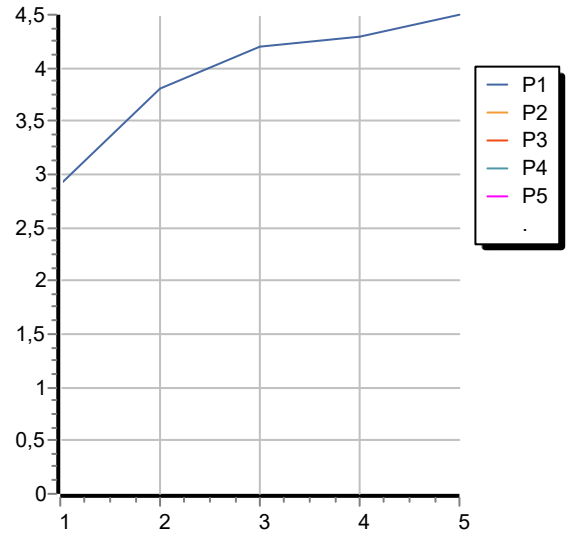

MEDAMEDA

ZMM5766 Pesì e Misure / Weights and Sizes

Peso (Kg) Weight (lb)	2,00 (Kg)	4,41 (lb)
Volume test (dc3) - (in3)	11,01 (dc3)	671,87 (in3)
h (mm) - (in)	90,00 (mm)	3,54 (in)
L1 (mm) - (in)	335,00 (mm)	13,19 (in)
L2 (mm) - (in)	365,00 (mm)	14,37 (in)

