

SHOWER

Z94164

Soffione doccia Ø 400 mm a soffitto. / Ø 400 mm ceiling mounted shower head.



















Soffione doccia Ø 400 mm in acciaio inox a soffitto con getto a pioggia.
Portata minima richiesta 10 l/min.
Portata massima limitata 12 l/min.

Nelle versioni verniciate, nebulizzatori e viti rimangono in finitura cromo/acciaio.

Ø 400 mm ceiling mounted stainless steel rain shower head.
Minimum flowrate requested 10 l/min.
Max waterflow limited 12 l/min.

In the painted versions, sprayers and screws remain in chrome/steel finish.

Finiture / Finishes

 C8 Cromo / Chrome	 C40 Nickel Lucido / Polished Nickel	 C41 Oro / Gold	 C50 Oro spazzolato / Brushed Gold	 C51 Metal Black / Metal Black	 P70 Metal Black spazzolato / Brushed Metal Black	
 W1 Bianco Opaco Goffrato / Embossed Matt White	 N1 Nero Opaco Goffrato / Embossed Matt Black	 N6 Nero opaco / Matt black	 L5 Blu mediterraneo / Mediterranean blu	 X Acciaio inox spazzolato / Brushed stainless steel	 XP21 Brushed PVD chocolate / Brushed PVD chocolate	 XP31 Brushed PVD British gold / Brushed PVD British gold
 XP41 Brushed PVD gold / Brushed PVD gold	 XP81 PVD Brushed Total Black / PVD Brushed Total Black	 XP91 Brushed PVD copper / Brushed PVD copper				

SHOWER

Z94164

Disegno Complessivo / Overall Drawing

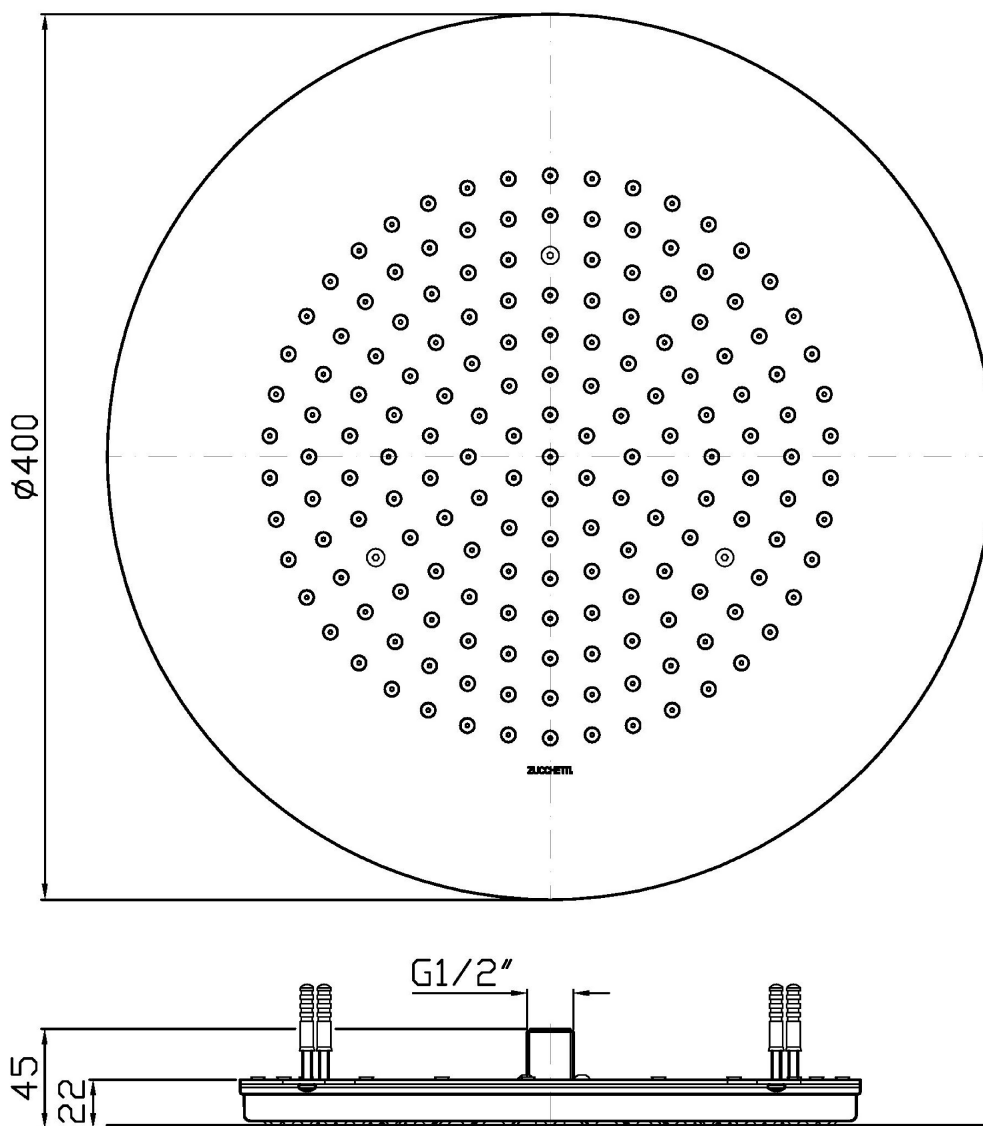

Note / Notes

SHOWER

Z94164

Portate / Flowrates (lt/min)

PRESSIONE PRESSURE	1 BAR	2 BAR	3 BAR	4 BAR	5 BAR
SOFFIONE SHOWER HEAD P1	8	10	12	12	12
P2					
P3					
P4					
P5					

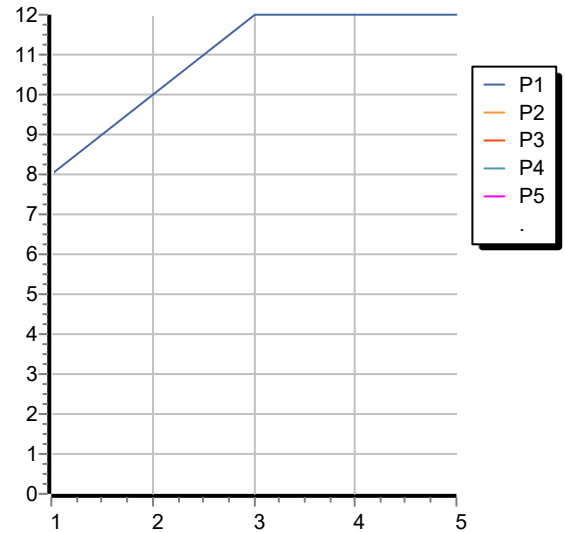

SHOWER

Z94164

Pesi e Misure / Weights and Sizes

Peso (Kg) Weight (lb)	3,60 (Kg)	7,94 (lb)
Volume test (dc3) - (in3)	8,96 (dc3)	546,77 (in3)
h (mm) - (in)	52,00 (mm)	2,05 (in)
L1 (mm) - (in)	410,00 (mm)	16,14 (in)
L2 (mm) - (in)	420,00 (mm)	16,54 (in)

