

PAN

ZP6124

Miscelatore monocomando lavabo incasso a 2 fori. / 2 hole built-in single lever basin mixer.



Miscelatore monocomando lavabo incasso con aeratore. Bocca 230 mm.
Water Saving - portata d'acqua uguale o inferiore a 6 l/min.











2 hole built-in single lever basin mixer with aerator. Spout projecton 230 mm.
Water Saving - water flow rate of 6 l/min or less.

R99815

Parte incasso. / Built-in part.



Finiture / Finishes

 Cromo / Chrome	 C3 Nickel Spazzolato / Brushed Nickel	 C8 Nickel Lucido / Polished Nickel	 C40 Oro / Gold	 C41 Oro spazzolato / Brushed Gold	 C50 Metal Black / Metal Black	 C51 Metal Black spazzolato / Brushed Metal Black	 W1 Bianco Opaco Goffrato / Embossed Matt White
 N1 Nero Opaco Goffrato / Embossed Matt Black	 N6 Nero opaco / Matt black						

PAN

ZP6124

Disegno Complessivo / Overall Drawing

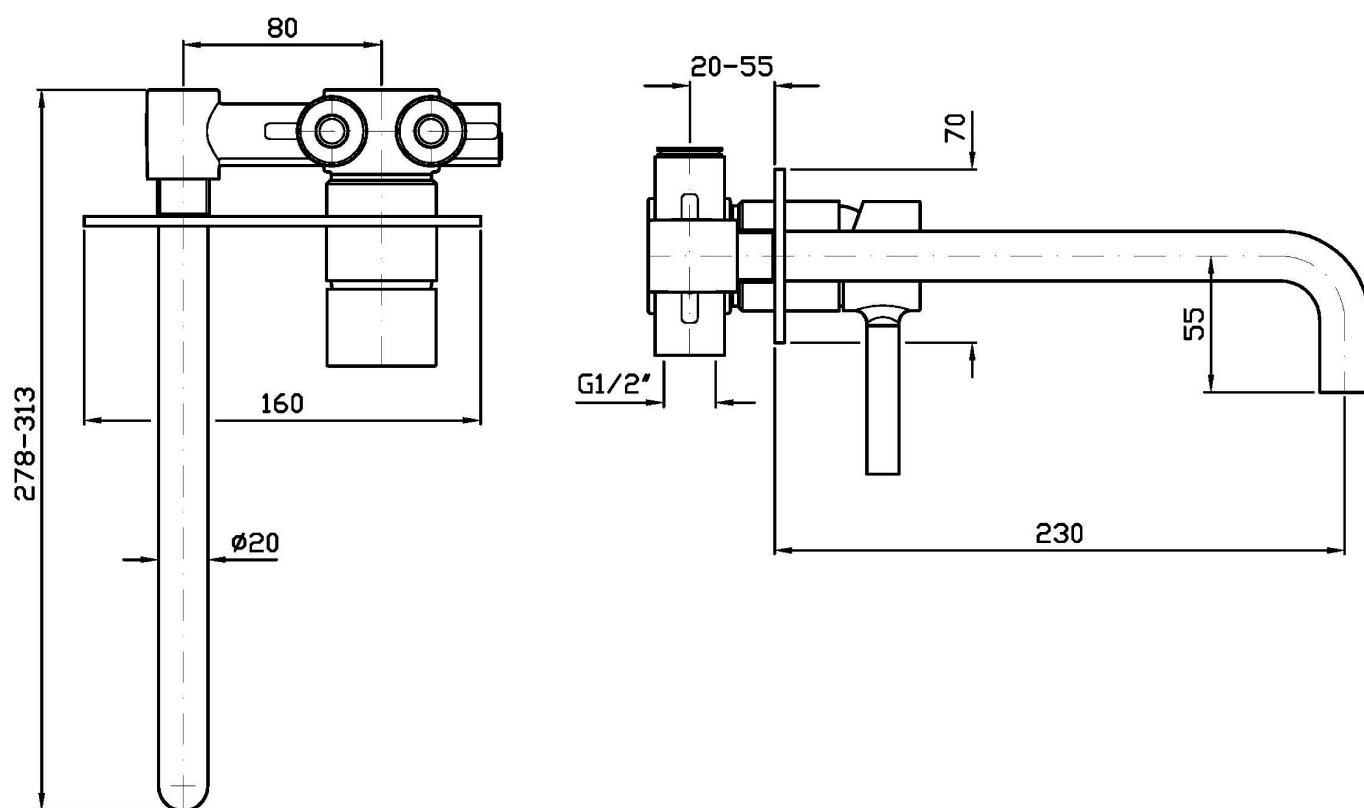

PAN

ZP6124

Esplosi / Exploded

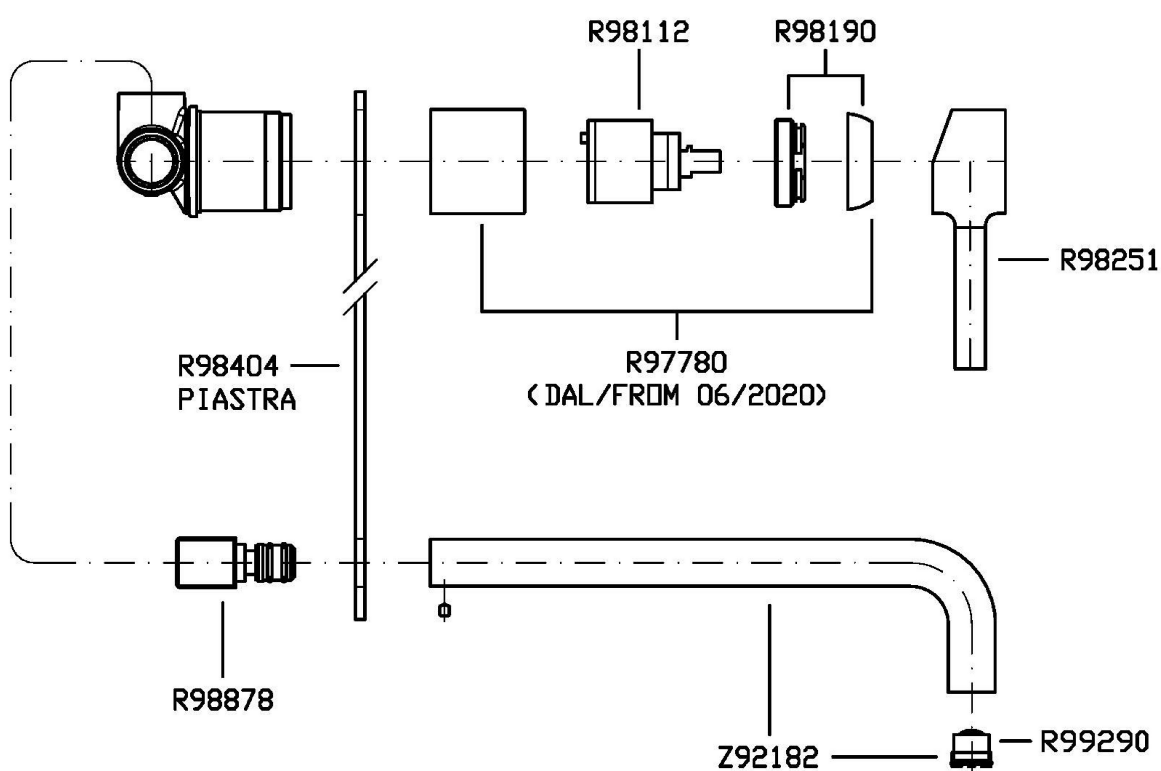

PAN

ZP6124

Portate / Flowrates (lt/min)

PRESSIONE PRESSURE	1 BAR	2 BAR	3 BAR	4 BAR	5 BAR
P1 LAVABO BASIN	4,8	5	5	5	5
P2					
P3					
P4					
P5					

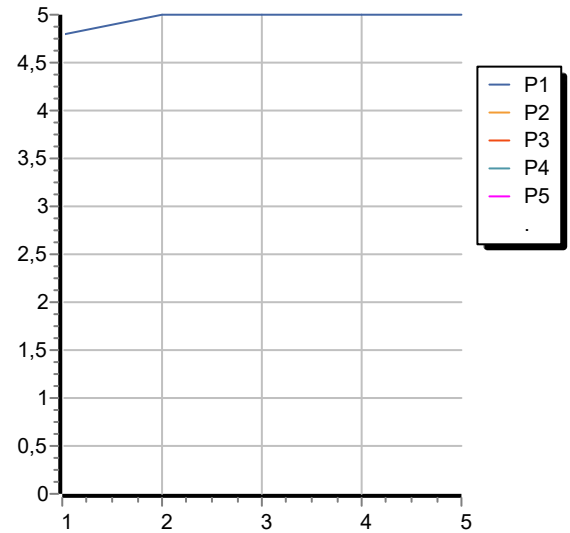

PAN

ZP6124

Pesi e Misure / Weights and Sizes

Peso (Kg) Weight (lb)	0,97 (Kg)	2,14 (lb)
Volume test (dc3) - (in3)	3,32 (dc3)	202,60 (in3)
h (mm) - (in)	93,00 (mm)	3,66 (in)
L1 (mm) - (in)	162,00 (mm)	6,38 (in)
L2 (mm) - (in)	220,00 (mm)	8,66 (in)

