

PAN

ZP6121

Miscelatore monocomando vasca-doccia incasso. / Built-in single lever bath-shower mixer.



Miscelatore monocomando vasca-doccia incasso con deviatore.









Built-in single lever bath-shower mixer with diverter.

R99684

Parte incasso. / Built-in part.



Finiture / Finishes

 Croma / Chrome	 C3 Nickel Spazzolato / Brushed Nickel	 C8 Nickel Lucido / Polished Nickel	 C40 Oro / Gold	 C41 Oro spazzolato / Brushed Gold	 C50 Metal Black / Metal Black	 C51 Metal Black spazzolato / Brushed Metal Black	 W1 Bianco Opaco Goffrato / Embossed Matt White
 N1 Nero Opaco Goffrato / Embossed Matt Black	 N6 Nero opaco / Matt black						

PAN

ZP6121

Disegno Complessivo / Overall Drawing

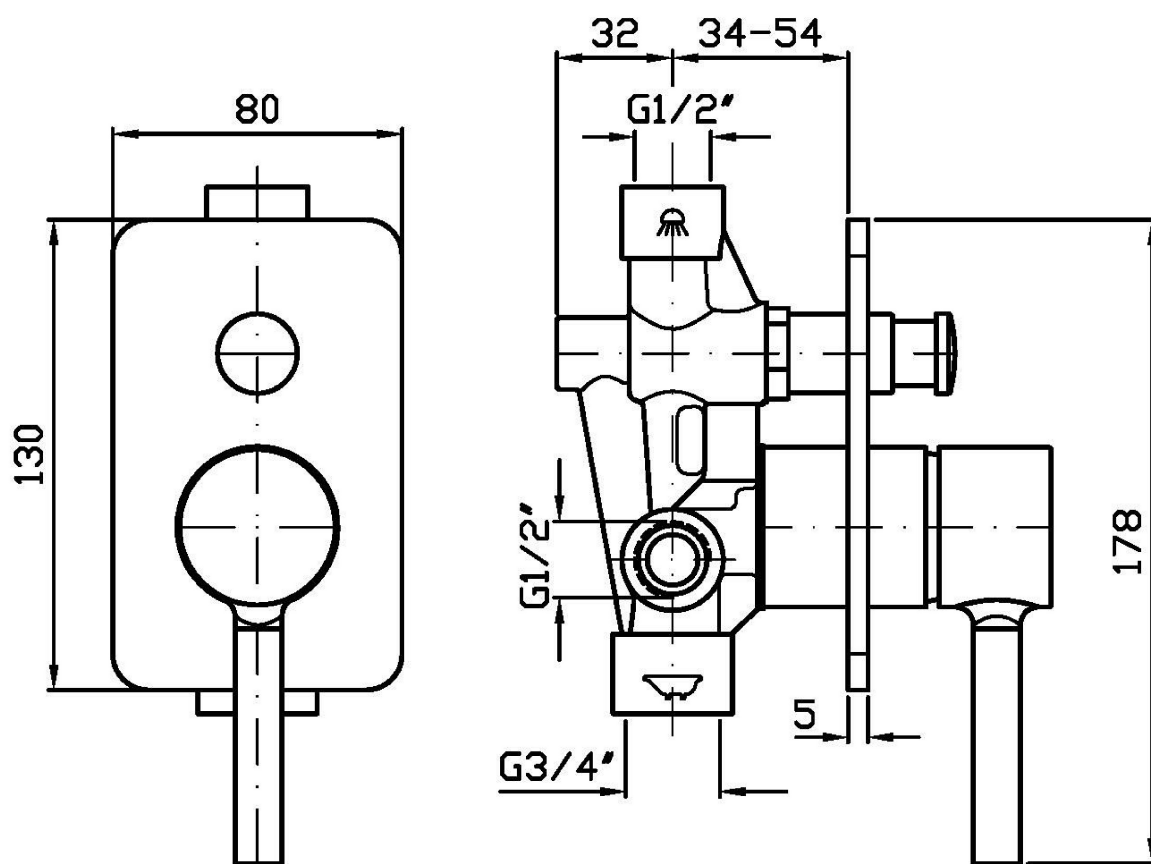

PAN

ZP6121

Esplosi / Exploded

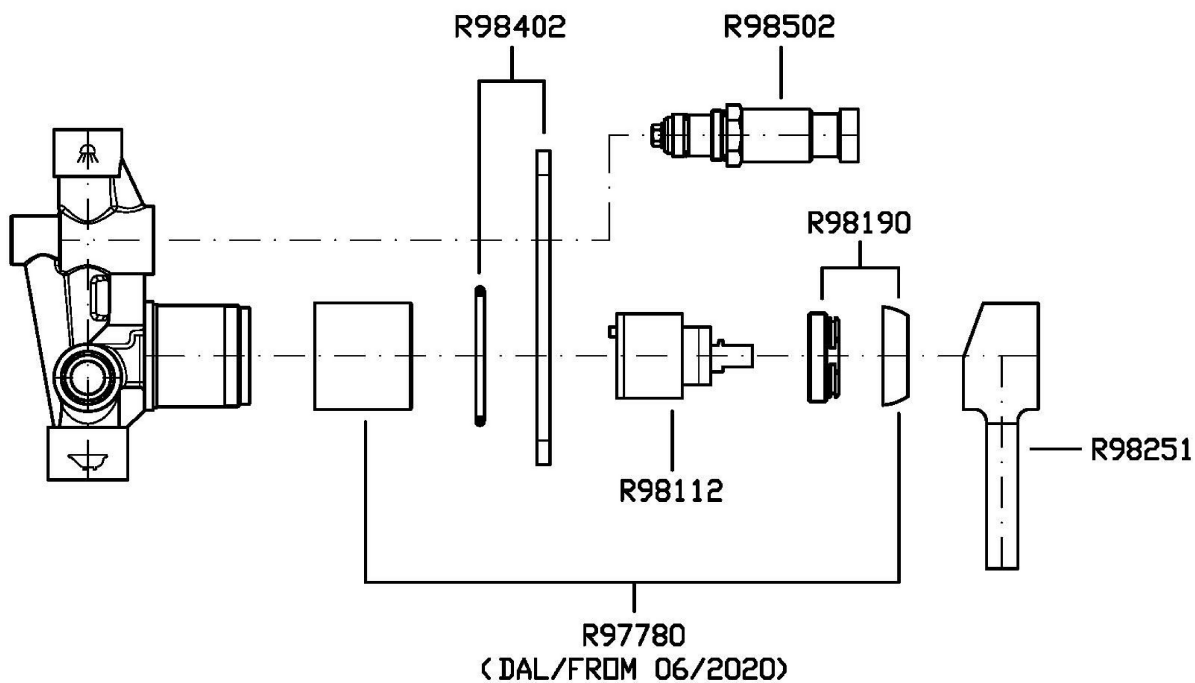

PAN

ZP6121

Certificazioni / Certifications

SINGAPORE

SETSCO

PAN

ZP6121

Portate / Flowrates (lt/min)

PRESSIONE PRESSURE	1 BAR	2 BAR	3 BAR	4 BAR	5 BAR
USCITA PRIMARIA PRIMARY OUTLET <i>P1</i>	15	21	26	30	34
USCITA SECONDARIA SECONDARY OUTLET <i>P2</i>	13	18	21	26	30
<i>P3</i>					
<i>P4</i>					
<i>P5</i>					

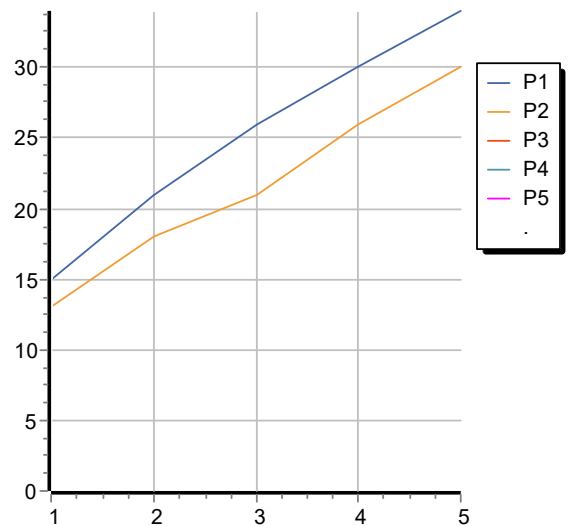

PAN

ZP6121

Pesi e Misure / Weights and Sizes

Peso (Kg) Weight (lb)	0,62 (Kg)	1,37 (lb)
Volume test (dc3) - (in3)	3,32 (dc3)	202,60 (in3)
h (mm) - (in)	93,00 (mm)	3,66 (in)
L1 (mm) - (in)	162,00 (mm)	6,38 (in)
L2 (mm) - (in)	220,00 (mm)	8,66 (in)

